

Thermal kiosk printer HS-K24 Specification



Contents

1 Introduction 1.1 Brief introduction	1
1.2 Main features.....	1
2 Dimension Figure and Pin Definitions	2
2.1 External Dimension Figure	2
2.2 Pin Definitions	3
3 Load paper roll direction.....	4
4 Technical specifications	3
5 List of Commands	4
6 Command in details.....	6
① Print and feed command.....	6
Print and line feed	6
Print and carriage return.....	6
Print and feed paper.....	6
Print and feed n lines	7
② Character command	7
Set line spacing	7
Select default line spacing.....	8
Set absolute print position.....	8
Set left space	8
Set horizontal and vertical movement unit.....	9
Set right-side character spacing.....	9
Select character font	10
Select print mode(s)	10
Select character size	11
Turn white/black reverse printing mode.....	12
Turn underline mode on/off.....	12
Turn 90°clockwise rotation mode on/off.....	13
Turn emphasized mode on/off.....	14
Turn double-strike mode on/off.....	14
Turn upside-down print mode on/off.....	14
Select justification (Left justification、centering、 Right justification)	14
Select Chinese character mode.....	15
Cancel Chinese character mode	15
Select print mode(s) for Chinese characters.....	16
Select an international character set	16
Select character code table	18
③ Bit image command	20
Print MSB BITMAP	20
Print LSB bitmap.....	20
Select bit-image mode.....	21
Define downloaded bit image	23
Print downloaded bit image.....	25

Define NV bit image	25
Print NV bit image	29
Print raster bit image	30
④ Tab command	31
Horizontal tab	31
Set horizontal tab positions	31
⑤ Bar code command	32
Select printing position for HRI characters	32
Select bar code height	33
Set bar code width	33
Print bar code	34
⑥ QR CODE COMMAND	38
Set the model type	38
Set the QR code error correction level error (ECC)	38
Set the QR code graphic data	38
Print store QR codes graphics	39
⑦ STATUS COMMAND	39
Transmit status	39
Real-time transmission status	40
Send real-time request to printer	42
Enable/Disable Automatic Status Back (ASB)	43
Set the process ID response	43
⑧ Other command	44
Initialize printer	44
Printing test paper	44
Select cut mode and cut paper	44
Partial cut (one point left uncut)	45
Partial cut (three points left uncut)	45
Set the print concentration	45

1 Introduction

1.1 Brief introduction

HS-K24 is a thermal embedded kiosk printer with high stability, which is widely used in receipt printing field.

HS-K24 connects other devices via USB or serial. The supported operating systems are as following:

WINDOWS XP
WINDOWS 7 32/64
WINDOWS 8
WINDOWS 10
UBUNTU 12.04 32/64
UBUNTU 14.04 32/64
MAC OS

1.2 Main features

- Thermal printer mechanism
- Support USB+Serial communication
- Easy paper loading
- Easy to integrate into kiosk designs
- **Automatic paper feeding**
- **Auto Cutter with long lifespan**
- **Paper near end and no paper fetch after printing out detection function**
- **With a mounting bracket, support big paper roll**

2 Dimension Figure and Pin Definitions

2.1 External Dimension Figure

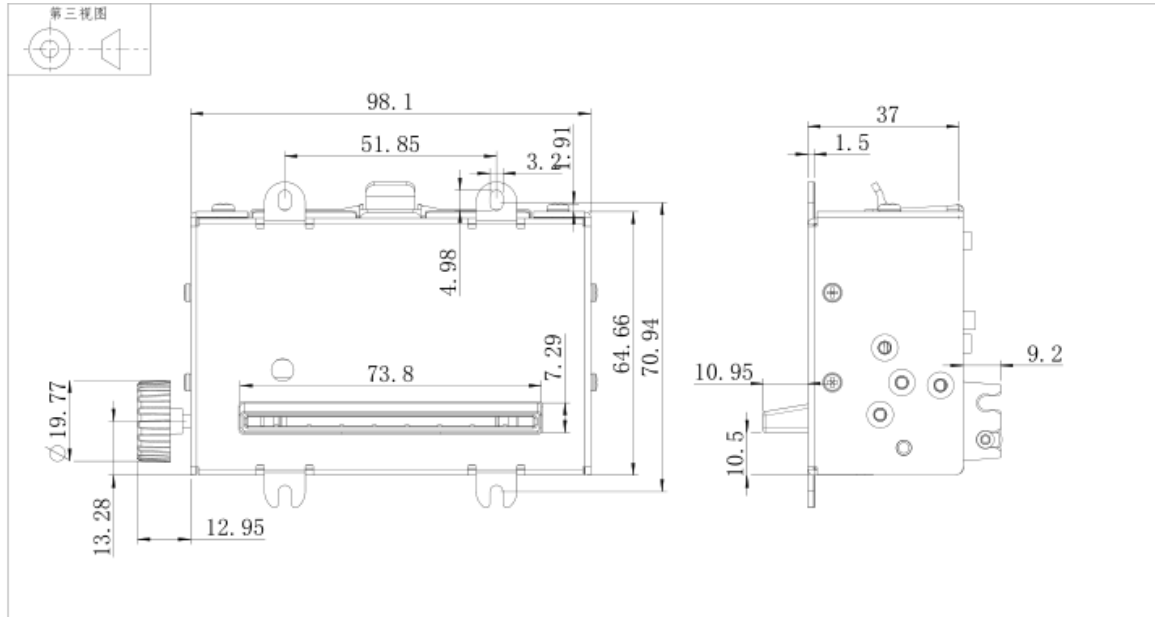

2.2 Pin Definitions

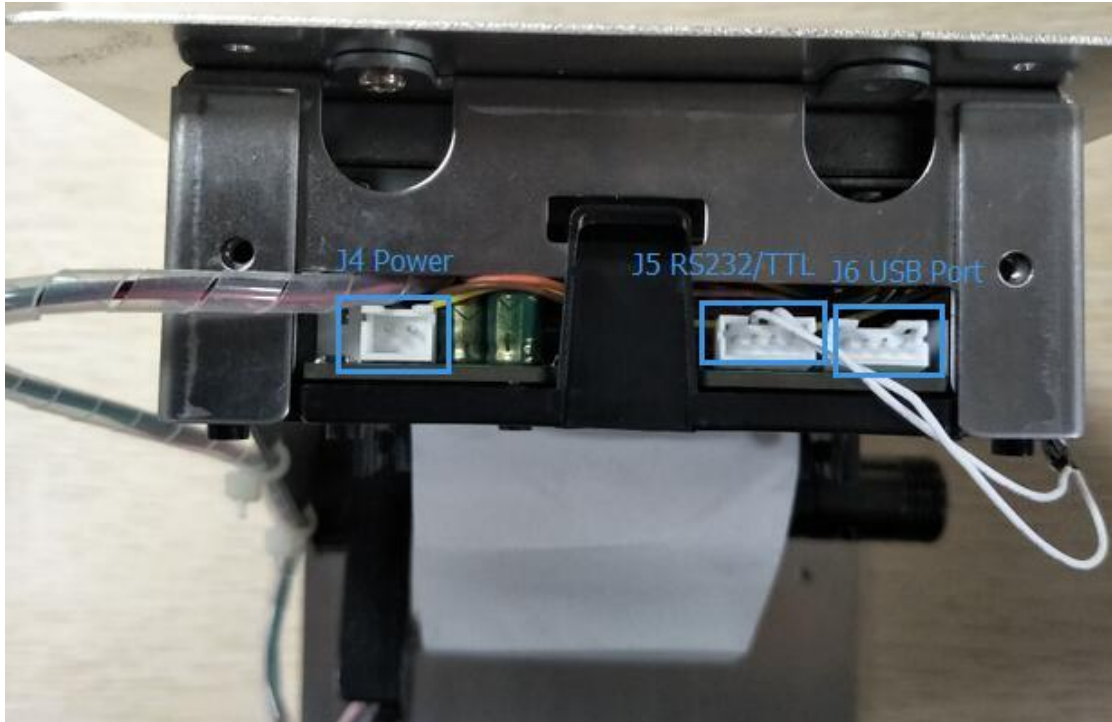

J6 USB port

Pin number	Pin number	Definition
1	VUSB	+5V
2	D-	DATA-
3	D+	DATA+
4	GND	GND

J4 Power supply

Pin number	Signal name	Definition
1	VIN	+12V
2	GND	GND

J5 RS232 interface

Pin number	Signal name	function
1	DTR(printer output)	output
2	TX(Tx,printer output)	output
3	RX(Rx, printer input)	input
4	GND	GND

3 Load paper roll direction



- Note: 1. Paper feed direction.
2. The printer has a manual operation roller which can be manually fed for option
3. Automatic paper feeding after the printer power on.

4 Technical specifications

Printing method	Thermal dot line printing
Paper width	58mm
Printing width	48mm
Resolution	203 DPI
Dots per line	384dots
Printing speed	120mm/s
Printing contents	Chinese, ASCII characters, 1D barcode, 2D barcode, Support dots printing with different densities, Support raster bitmap print, Support to download the bitmap print
Font(default)	9X17, 9×24, 8×16, 16×18, 12X24(ASCII), 24x24(Chinese)

5 List of Commands

LF	Print and line feed	Print and feed command
CR	Print and carriage return	
ESC J	Print and feed n points	
ESC d	Print and feed n lines	
ESC 3	Set n points line spacing	Character command
ESC 2	Select default line spacing	
ESC \$ nL nH	Set absolute print position	
GS L nL nH	Set left space	
ESC SP n	Set right-side character spacing	
ESC M n	Select character font	
ESC ! n	Select print mode(s)	
GS ! n	Select character size	
GS B n	Turn white/black reverse printing mode	
ESC - n	Turn underline mode on/off	
ESC V n	Turn 90° clockwise rotation mode on/off	
ESC E n	Turn emphasized mode on/off	
ESC G n	Turn double-strike mode on/off	
ESC { n	Turn upside-down print mode on/off	
ESC a n	Select justification	
FS &	Select Chinese character mode	
FS .	Cancel Chinese character mode	
FS ! n	Select print mode(s) for Chinese characters	
ESC R n	Select an international character set	
ESC t n	Select character code table	
DC2 V	Printer MSB Bitmap	Bit image command
DC2 v	Printer LSB Bitmap	
ESC *	Select bit-image mode	
GS *	Define downloaded bit image	
GS / m	Print downloaded bit image	
FS q	Define NV bit image	
FS p n m	Print NV bit image	
GS v 0 m	Print raster bit image	
HT	Horizontal tab	Tab command
ESC D	Set horizontal tab positions	
GS H	Select printing position for HRI characters	Bar code command
GS h	Select bar code height	
GS w	Set bar code width	
GS k	Print bar code	
GS (k pL pH cn fn n (fn=67)	Set the module type	QR code command
GS (k pL pH cn fn	Set the QR code error correction level error	

n (fn=69)	(ECC)	
GS (k pL pH cn fn m d1...dk (fn=80)	Set the QR code graphic data	
GS (k pL pH cn fn m (fn=81)	Print store QR codes graphics	
GS r n	Transmit status	STATUS command
DLE EOT n	Real-time transmission status	
DLE ENQ n	Send real-time request to printer	
GS a n	Enable/Disable Automatic Status Back (ASB)	
GS a n	Set the process ID response	
ESC @	Initialize printer	Other command
DC2 T	Printing test paper	
GS V	Select cut mode and cut paper	
ESC i	Partial cut (one point left uncut)	
ESC m	Partial cut (three points left uncut)	
ESC 7	Set the print concentration	

6 Command in details

① Print and feed command

Print and line feed

Name	Print and line feed
Format	ASCII : LF Decimal : 10 Hex : 0A
Description	Prints the data in the print buffer and feeds one line, based on the current line spacing.
Range	
Default	
Support model	All the printers
Note	
For Example	1B 40 1C 26 30 31 32 41 42 43 CFC3C3C5BFAAB4CFB5E7D7D3 0d 0a 1b 4a 10 1B 40 1C 26 30 31 32 41 42 43 CFC3C3C5BFAAB4CFB5E7D7D3 0d 0a 1b 4a 30 1B 40 1C 26 30 31 32 41 42 43 CFC3C3C5BFAAB4CFB5E7D7D3 0d 0a

Print and carriage return

Name	Print and carriage return
Format	ASCII : CR Decimal : 13 Hex : 0D
Description	When automatic line feed is enabled, this command functions the same as LF ; when automatic line feed is disabled, this command is ignored.
Range	
Default	
Support model	All the printers
Note	This command line feed is ignored with a serial interface model. Sets the print starting position to the beginning of the line.
For Example	

Print and feed paper

Name	Print and feed paper
Format	ASCII : ESC J n Decimal : 27 74 n Hex : 1B 4A n
Description	Prints the data in the print buffer and feeds the paper [$n \times 0.125$ mm (0.0049")].
Range	$0 \leq n \leq 255$

Default	
Support modal	All the printers
Note	<p>After printing is completed, this command sets the print starting position to the beginning of the line.</p> <p>The paper feed amount set by this command does not affect the values set by ESC 2 or ESC 3.</p> <p>In standard mode, the printer uses the vertical motion unit (y).</p>
For example	1b 40 30 31 32 1b 4a 10

Print and feed n lines

Name	Print and feed n lines
Format	<p>ASCII : ESC d n</p> <p>Decimal : 27 100 n</p> <p>Hex : 1B 64 n</p>
Description	Prints the data in the print buffer and feeds n lines.
Range	$0 \leq n \leq 255$
Default	
Support modal	All the printers
Note	<p>This command sets the print starting position to the beginning of the line.</p> <p>This command does not affect the line spacing set by ESC 2 or ESC 3.</p> <p>The maximum paper feed amount is 1016 mm (40 inches). If the paper feed amount (n line spacing) of more than 1016 mm (40 inches) is specified, the printer feeds the paper only 1016 mm (40 inches).</p>
For example	<p>1b 40 1C 26 30 31 32 41 42 43 CFC3C3C5BFAAB4CFB5E7D7D3 1b 64 01</p> <p>1b 40 1C 26 30 31 32 41 42 43 CFC3C3C5BFAAB4CFB5E7D7D3 1b 64 02</p> <p>1b 40 1C 26 30 31 32 41 42 43 CFC3C3C5BFAAB4CFB5E7D7D3 1b 64 00</p>

② Character command

Set line spacing

Name	Set line spacing
Format	<p>ASCII : ESC 3 n</p> <p>Decimal : 27 51 n</p> <p>Hex : 1B 33 n</p>
Description	Sets the line spacing to [n×0.125 mm].
Range	$0 \leq n \leq 255$
Default	n = 33
Support modal	All the printers
Note	 <p>If set the line spacing is less than the maximum character height in a line, so the bank line spacing is equal to the maximum character level.</p> <p>The line spacing can be set default values, when appear ESC 2, ESC @, reset</p>

	the printer and printer power
For example	1b 40 1b 33 30 1C 26 30 31 32 41 42 43 CFC3C3C5BFAAB4CFB5E7D7D3 0d 0a 1C 26 30 31 32 41 42 43 CFC3C3C5BFAAB4CFB5E7D7D3 0d 0a 1C 26 30 31 32 41 42 43 CFC3C3C5BFAAB4CFB5E7D7D3 0d 0a 1b 32 1C 26 30 31 32 41 42 43 CFC3C3C5BFAAB4CFB5E7D7D3 0d 0a

Select default line spacing

Name	Select default line spacing
Format	ASCII : ESC 2 Decimal : 27 50 Hex : 1B 32
Description	Selects 4.125mm (33× 0.125 mm) line spacing.
Range	0 n 255
Default	33 Dots
Support modal	All the printers
Note	With reference to ESC 3 command. If set the line spacing is less than the maximum character height in a line, so the bank line spacing is equal to the maximum character level.
For example	

Set absolute print position

Name	Set absolute print position
Format	ASCII : ESC \$ nL nH Decimal : 27 36 nL nH Hex : 1B 24 nL nH
Description	The distance from the beginning of the line to the print position is[(nL + nH×256)×0.125 mm].
Range	$0 \leq nL \leq 255$, $0 \leq nH \leq 255$
Default	
Support modal	All the printers
Note	Settings outside the specified printable area are ignored. In standard mode, the horizontal motion unit (x) is used.
For example	1b 40 1b 24 20 00 1C 26 30 31 32 41 42 43 CFC3C3C5BFAAB4CFB5E7D7D3 0d 0a 1C 26 30 31 32 41 42 43 CFC3C3C5BFAAB4CFB5E7D7D3 0d 0a

Set left space

Name	Set left space
Format	ASCII : GS L nL nH Decimal : 29 76 nL nH

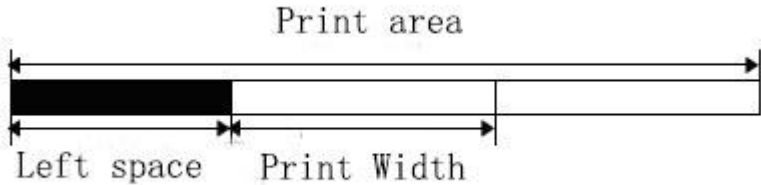
	Hex : 1D 4C nL nH
Description	Set left space (nL + nH × 256) dots.
Range	0 ≤ nL ≤ 255, 0 ≤ nH ≤ 255
Default	
Support modal	All the printers
Note	<p>This command is only effective in a line of the starting position of the treatment.</p> <p>As shown in the figure:</p>  <p>If set outside the printable area, use the maximum printing unit.</p>
For example	<pre>1b 40 1d 4c 50 00 1C 26 30 31 32 41 42 43 CFC3C3C5BFAAB4CFB5E7D7D3 0d 0a 1C 26 30 31 32 41 42 43 CFC3C3C5BFAAB4CFB5E7D7D3 0d 0a</pre>

Set horizontal and vertical movement unit

Name	Set horizontal and vertical movement unit
Format	ASCII : GS P x y Decimal : 29 80 x y HEX : 1D 50 x y
Description	<ul style="list-style-type: none"> • Set approximation horizontal movement unit 25.4/ x mm (1/ x inch) ; set approximation vertical movement unit 25.4/ y mm (1/ y inch). •When x and y is 0,the x and y is set to default.
Range	0 ≤ x ≤ 255, 0 ≤ y ≤ 255
Default	x = 200, y = 380, a movement unit is the point of a print. The horizontal distance is about 1/8mm ; the vertical distance is about 1/15mm.
Support modal	80XXX
Note	
For example	<pre>1d 50 c8 c8 1B 4C 1B 57 30 00 00 00 78 00 30 00 1B 33 18 1B 57 30 31 32 30 31 32 30 31 32 30 31 32 30 31 32 30 31 32 30 31 32 30 31 32 30 31 32 30 31 32 30 31 32 30 31 32 30 31 32 30 31 32 30 31 32 0C</pre>

Set right-side character spacing

[Name] Set right-side character spacing

[Format] ASCII ESC SP n
 Hex 1B 20 n
 Decimal 27 32 n

[Range] $0 \leq n \leq 255$

[Default] $n = 0$

[Description] • Sets the right-side character spacing to $[n \times (\text{horizontal or vertical motion unit})]$.

[Note] • The maximum right-side spacing is 35.98 mm {255/180"}.

Select character font

[Name] Select character font

[Format] ASCII ESC M n
 Hex 1B 4D n
 Decimal 27 77 n

[Range] $n = 0, 1, 48, 49$

[Default] $n = 0$

[Description] • Selects a character font.

n	Character font
0, 48	Character font A (12 × 24)
1, 49	Character font B (9×24) 。
2, 50	Character font C (9×17)
3, 51	Character font D (8×16)

[Note] • When auto replacement of the font with the customized value, ESC ! is set for the selected font, the font to be replaced is enabled.

Select print mode(s)

Name	Select print mode(s)																																						
Format	ASCII : ESC ! n Decimal : 27 33 n Hex : 1B 21 n																																						
Description	Selects print mode(s) using n as follows: (Font、white/black reverse、Inversion、Bold、double-height、double-width、underline) <table style="margin-left: 40px;"> <thead> <tr> <th rowspan="2">bit</th> <th rowspan="2">function</th> <th colspan="2">value</th> </tr> <tr> <th>0</th> <th>1</th> </tr> </thead> <tbody> <tr> <td>0</td> <td>font</td> <td>normal</td> <td>small</td> </tr> <tr> <td>1</td> <td>inverse</td> <td>cancel</td> <td>set</td> </tr> <tr> <td>2</td> <td>inversion</td> <td>cancel</td> <td>set</td> </tr> <tr> <td>3</td> <td>bold</td> <td>cancel</td> <td>set</td> </tr> <tr> <td>4</td> <td>double-height</td> <td>cancel</td> <td>set</td> </tr> <tr> <td>5</td> <td>double-width</td> <td>cancel</td> <td>set</td> </tr> <tr> <td>6</td> <td>underline</td> <td>cancel</td> <td>set</td> </tr> <tr> <td>7</td> <td>undefined</td> <td></td> <td></td> </tr> </tbody> </table>	bit	function	value		0	1	0	font	normal	small	1	inverse	cancel	set	2	inversion	cancel	set	3	bold	cancel	set	4	double-height	cancel	set	5	double-width	cancel	set	6	underline	cancel	set	7	undefined		
bit	function			value																																			
		0	1																																				
0	font	normal	small																																				
1	inverse	cancel	set																																				
2	inversion	cancel	set																																				
3	bold	cancel	set																																				
4	double-height	cancel	set																																				
5	double-width	cancel	set																																				
6	underline	cancel	set																																				
7	undefined																																						
Range																																							
Default	$n = 0$																																						
Supprot modal	All the printers																																						

Note	The command for Chinese fonts and foreign fonts are effective ESC @,dump and restart,Reset the printer,This command setting failure
For example	1B 40 1B 21 01 30 31 32 0D 0A 1B 40 1B 21 02 30 31 32 0D 0A 1B 40 1B 21 04 30 31 32 0D 0A 1B 40 1B 21 08 30 31 32 0D 0A 1B 40 1B 21 10 30 31 32 0D 0A 1B 40 1B 21 20 30 31 32 0D 0A 1B 40 1B 21 40 30 31 32 0D 0A 1B 40 1B 21 80 30 31 32 0D 0A

Select character size

Name	Select character size																																																										
Formal	ASCII : GS ! n Decimal : 29 33 n HEX : 1d 21 n																																																										
Description	<p>1 vertical number of times 8, 1 horizontal number of times 8 Selects the character height using bits 0 to 2 and selects the character width using bits 4 to 7, as follows:</p> <table style="width: 100%; border: none;"> <tr> <td style="text-align: center; width: 50%;">Table 1 Set the width of character</td> <td style="text-align: center; width: 50%;">Table 2 Set the height of character</td> </tr> </table> <table style="width: 100%; border-collapse: collapse; border: none;"> <tr> <td style="width: 50%; border: none;"> <table border="1" style="width: 100%; border-collapse: collapse;"> <thead> <tr> <th>HEX</th> <th>Decimal</th> <th>width</th> </tr> </thead> <tbody> <tr><td>00</td><td>0</td><td>1(normal)</td></tr> <tr><td>10</td><td>16</td><td>2(double-width)</td></tr> <tr><td>20</td><td>32</td><td>3</td></tr> <tr><td>30</td><td>48</td><td>4</td></tr> <tr><td>40</td><td>64</td><td>5</td></tr> <tr><td>50</td><td>80</td><td>6</td></tr> <tr><td>60</td><td>96</td><td>7</td></tr> <tr><td>70</td><td>112</td><td>8</td></tr> </tbody> </table> </td> <td style="width: 50%; border: none;"> <table border="1" style="width: 100%; border-collapse: collapse;"> <thead> <tr> <th>HEX</th> <th>Decimal</th> <th>width</th> </tr> </thead> <tbody> <tr><td>00</td><td>0</td><td>1(normal)</td></tr> <tr><td>01</td><td>1</td><td>2(double-height)</td></tr> <tr><td>02</td><td>2</td><td>3</td></tr> <tr><td>03</td><td>3</td><td>4</td></tr> <tr><td>04</td><td>4</td><td>5</td></tr> <tr><td>05</td><td>5</td><td>6</td></tr> <tr><td>06</td><td>6</td><td>7</td></tr> <tr><td>07</td><td>7</td><td>8</td></tr> </tbody> </table> </td> </tr> </table>	Table 1 Set the width of character	Table 2 Set the height of character	<table border="1" style="width: 100%; border-collapse: collapse;"> <thead> <tr> <th>HEX</th> <th>Decimal</th> <th>width</th> </tr> </thead> <tbody> <tr><td>00</td><td>0</td><td>1(normal)</td></tr> <tr><td>10</td><td>16</td><td>2(double-width)</td></tr> <tr><td>20</td><td>32</td><td>3</td></tr> <tr><td>30</td><td>48</td><td>4</td></tr> <tr><td>40</td><td>64</td><td>5</td></tr> <tr><td>50</td><td>80</td><td>6</td></tr> <tr><td>60</td><td>96</td><td>7</td></tr> <tr><td>70</td><td>112</td><td>8</td></tr> </tbody> </table>	HEX	Decimal	width	00	0	1(normal)	10	16	2(double-width)	20	32	3	30	48	4	40	64	5	50	80	6	60	96	7	70	112	8	<table border="1" style="width: 100%; border-collapse: collapse;"> <thead> <tr> <th>HEX</th> <th>Decimal</th> <th>width</th> </tr> </thead> <tbody> <tr><td>00</td><td>0</td><td>1(normal)</td></tr> <tr><td>01</td><td>1</td><td>2(double-height)</td></tr> <tr><td>02</td><td>2</td><td>3</td></tr> <tr><td>03</td><td>3</td><td>4</td></tr> <tr><td>04</td><td>4</td><td>5</td></tr> <tr><td>05</td><td>5</td><td>6</td></tr> <tr><td>06</td><td>6</td><td>7</td></tr> <tr><td>07</td><td>7</td><td>8</td></tr> </tbody> </table>	HEX	Decimal	width	00	0	1(normal)	01	1	2(double-height)	02	2	3	03	3	4	04	4	5	05	5	6	06	6	7	07	7	8
Table 1 Set the width of character	Table 2 Set the height of character																																																										
<table border="1" style="width: 100%; border-collapse: collapse;"> <thead> <tr> <th>HEX</th> <th>Decimal</th> <th>width</th> </tr> </thead> <tbody> <tr><td>00</td><td>0</td><td>1(normal)</td></tr> <tr><td>10</td><td>16</td><td>2(double-width)</td></tr> <tr><td>20</td><td>32</td><td>3</td></tr> <tr><td>30</td><td>48</td><td>4</td></tr> <tr><td>40</td><td>64</td><td>5</td></tr> <tr><td>50</td><td>80</td><td>6</td></tr> <tr><td>60</td><td>96</td><td>7</td></tr> <tr><td>70</td><td>112</td><td>8</td></tr> </tbody> </table>	HEX	Decimal	width	00	0	1(normal)	10	16	2(double-width)	20	32	3	30	48	4	40	64	5	50	80	6	60	96	7	70	112	8	<table border="1" style="width: 100%; border-collapse: collapse;"> <thead> <tr> <th>HEX</th> <th>Decimal</th> <th>width</th> </tr> </thead> <tbody> <tr><td>00</td><td>0</td><td>1(normal)</td></tr> <tr><td>01</td><td>1</td><td>2(double-height)</td></tr> <tr><td>02</td><td>2</td><td>3</td></tr> <tr><td>03</td><td>3</td><td>4</td></tr> <tr><td>04</td><td>4</td><td>5</td></tr> <tr><td>05</td><td>5</td><td>6</td></tr> <tr><td>06</td><td>6</td><td>7</td></tr> <tr><td>07</td><td>7</td><td>8</td></tr> </tbody> </table>	HEX	Decimal	width	00	0	1(normal)	01	1	2(double-height)	02	2	3	03	3	4	04	4	5	05	5	6	06	6	7	07	7	8				
HEX	Decimal	width																																																									
00	0	1(normal)																																																									
10	16	2(double-width)																																																									
20	32	3																																																									
30	48	4																																																									
40	64	5																																																									
50	80	6																																																									
60	96	7																																																									
70	112	8																																																									
HEX	Decimal	width																																																									
00	0	1(normal)																																																									
01	1	2(double-height)																																																									
02	2	3																																																									
03	3	4																																																									
04	4	5																																																									
05	5	6																																																									
06	6	7																																																									
07	7	8																																																									
Range																																																											
Default	n = 0																																																										
Suuport modal	All the printers																																																										
Note	This command is effective for all characters (alphanumeric and Chinese), except for HRI characters. ESC @,dump and restart,Reset the printer,This command setting failure.																																																										
For example	1b 40 1c 26 1d 21 10 30 31 32 B0 AE CE D2 D6 D0 BB AA 0d 0a 1B 40 1c 26																																																										

	1d 21 01 30 31 32 B0 AE CE D2 D6 D0 BB AA 0d 0a 1B 40 1c 26 1d 21 11 30 31 32 B0 AE CE D2 D6 D0 BB AA 0d 0a
--	---

Turn white/black reverse printing mode

Name	Turn white/black reverse printing mode
Format	ASCII : GS B n Decimal : 29 66 n HEX : 1d 42 n
Description	Turns on or off white/black reverse printing mode. When the LSB of n is 0, white/black reverse mode is turned off. When the LSB of n is 1, white/black reverse mode is turned on.
Range	
Default	n = 0
Support modal	All the printers
Note	Only the lowest bit of n is valid. This command is available for built-in characters and user-defined characters. When white/black reverse printing mode is on, it also applies to character spacing set by ESC SP . This command does not affect bit images, user-defined bit images, bar codes, HRI characters, and spacing skipped by HT , ESC \$. This command does not affect the space between lines. White/black reverse mode has a higher priority than underline mode. Even if underline mode is on, it is disabled (but not canceled) when white/black reverse mode is selected.
For example	1b 40 1c 26 1d 42 00 30 31 32 41 42 43 CFC3C3C5BFAAB4CFB5E7D7D3 0d 0a 1b 40 1c 26 1d 42 01 30 31 32 41 42 43 CFC3C3C5BFAAB4CFB5E7D7D3 0d 0a

Turn underline mode on/off

Name	Turn underline mode on/off								
Format	ASCII : ESC - n Decimal : 27 45 n HEX : 1B 2D n								
Description	Turns underline mode on or off, based on the following values n: <table border="1" style="margin-left: 20px;"> <thead> <tr> <th>n</th> <th>Function</th> </tr> </thead> <tbody> <tr> <td>0, 48</td> <td>Turns off underline mode</td> </tr> <tr> <td>1, 49</td> <td>Turns on underline mode (1 dot thick)</td> </tr> <tr> <td>2, 50</td> <td>Turns on underline mode (2 dots thick)</td> </tr> </tbody> </table>	n	Function	0, 48	Turns off underline mode	1, 49	Turns on underline mode (1 dot thick)	2, 50	Turns on underline mode (2 dots thick)
n	Function								
0, 48	Turns off underline mode								
1, 49	Turns on underline mode (1 dot thick)								
2, 50	Turns on underline mode (2 dots thick)								
Range	$0 \leq n \leq 2, 48 \leq n \leq 50$								

Default	n = 0
Support modal	All the printers
Note	<p>The printer can underline all characters (including right-side character spacing), but cannot underline the space set by HT.</p> <p>The printer cannot underline 90° clockwise rotated characters and white/black inverted characters.</p> <p>When underline mode is turned off by setting the value of n to 0 or 48, the following data is not underlined, and the underline thickness set before the mode is turned off does not change. The default underline thickness is 1 dot.</p> <p>Changing the character size does not affect the current underline thickness.</p> <p>Underline mode can also be turned on or off by using ESC !. Note,</p>
For example	<pre>1b 40 1c 26 1b 2d 01 30 31 32 41 42 43 B0 AE CE D2 D6 D0 BB AA 0D 0A 1b 40 1c 26 1b 2d 02 30 31 32 41 42 43 B0 AE CE D2 D6 D0 BB AA 0D 0A 1b 40 1c 26 1b 2d 00 30 31 32 41 42 43 B0 AE CE D2 D6 D0 BB AA 0D 0A</pre>

Turn 90° clockwise rotation mode on/off

Name	Turn 90° clockwise rotation mode on/off						
Format	<p>ASCII : ESC V n</p> <p>Decimal : 27 86 n</p> <p>HEX : 1B 56 n</p>						
Description	<p>Turns 90° clockwise rotation mode on/off n is used as follows:</p> <table border="1" style="margin-left: 20px;"> <thead> <tr> <th>n</th> <th>Function</th> </tr> </thead> <tbody> <tr> <td>0,48</td> <td>Turns off 90° clockwise rotation mode</td> </tr> <tr> <td>1,49</td> <td>Turns on 90° clockwise rotation mode</td> </tr> </tbody> </table>	n	Function	0,48	Turns off 90° clockwise rotation mode	1,49	Turns on 90° clockwise rotation mode
n	Function						
0,48	Turns off 90° clockwise rotation mode						
1,49	Turns on 90° clockwise rotation mode						
Range	$0 \leq n \leq 1$, $48 \leq n \leq 49$						
Default	n = 0						
Support modal	All the printers						
Note	<p>This command affects printing in standard mode. However, the setting is always effective.</p> <p>When underline mode is turned on, the printer does not underline 90° clockwise-rotated characters.</p> <p>Double-width and double-height commands in 90° rotation mode enlarge characters in the opposite directions from double-height and double-width commands in normal mode.</p>						
For example	<pre>1b 40 1c 26 1b 56 01 30 31 32 41 42 43 CFC3C3C5BFAAB4CFB5E7D7D3 0d 0a 1b 40 1c 26 1b 56 00 30 31 32 41 42 43 CFC3C3C5BFAAB4CFB5E7D7D3 0d 0a</pre>						

Turn emphasized mode on/off

[Name] Turn emphasized mode on/off

[Format] ASCII ESC E n
 Hex 1B 45 n
 Decimal 27 69 n

[Range] $0 \leq n \leq 255$

[Default] $n = 0$

[Description] • Turns emphasized mode on or off.
 • When the LSB of n is 0, turns off emphasized mode.
 • When the LSB of n is 1, turns on emphasized mode.

Turn double-strike mode on/off

[Name] Turn double-strike mode on/off

[Format] ASCII ESC G n
 Hex 1B 47 n
 Decimal 27 71 n

[Range] $0 \leq n \leq 255$

[Default] $n = 0$

[Description] • Turns double-strike mode on or off.
 • When the LSB of n is 0, turns off double-strike mode.
 • When the LSB of n is 1, turns on double-strike mode.

Turn upside-down print mode on/off

[Name] Turn upside-down print mode on/off

[Format] ASCII ESC { n
 Hex 1B 7B n
 Decimal 27 123 n

[Range] $0 \leq n \leq 255$

[Default] $n = 0$

[Description] • In standard mode, turns upside-down print mode on or off.
 • When the LSB of n is 0, turns off upside-down print mode.
 • When the LSB of n is 1, turns on upside-down print mode.

Select justification (Left justification、centering、Right justification)

Name	Select justification (left、center、right)	
Format	ASCII : ESC a n Decimal : 27 97 n HEX : 1B 61 n	
Description	Aligns all the data in one line to the specified position.n selects the justification as follows:	
	n	Justification
	0,48	Left justification

	1, 49	Centering
	2, 50	Right justification
Range	$0 \leq n \leq 2$ or $48 \leq n \leq 50$	
Default	n = 0	
Support modal	All the printers	
Note	ESC @,dump and restart,Reset the printer,This command setting failure.	
Example	1B 40 1B 61 02 30 31 32 0D 0A 1B 40 1B 61 01 30 31 32 0D 0A 1B 40 1B 61 00 30 31 32 0D 0A	

Select Chinese character mode

Name	Select Chinese character mode
Format	ASCII : FS & Decimal : 28 38 HEX : 1C 26
Description	Selects Chinese character mode.
Range	
Default	
Support modal	All the printers
Note	For Chinese model: When the Chinese character mode is selected, the printer processes all Chinese code as two bytes each. Chinese codes are processed in the order of the first byte and second byte. Chinese character mode is not selected when the power is turned on.
For example	1b 40 1C 26 B0 AE C9 CF D7 D4 BC BA 0d 0a 1C 2E B0 AE C9 CF D7 D4 BC BA 0d 0a

Cancel Chinese character mode

Name	Cancel Chinese character mode
Format	ASCII : FS . Decimal : 28 46 HEX : 1C 2E
Description	Cancel Chinese character mode
Range	
Default	
Support modal	All the printers
Note	For Chinese model: When the Chinese character mode is not selected, all character codes are processed one byte at a time as ASCII code. Chinese character mode is not selected when the power is turned on.

For example	

Select print mode(s) for Chinese characters

[Name] Select print mode(s) for Chinese characters

[Format] ASCII FS ! n

Hex 1C 21 n

Decimal 28 33 n

[Range] $0 \leq n \leq 255$

[Default] n = 0

[Description] • Selects the character styles (double-height, double-width, and Chinese-underlined) together for multi-byte code character.

(n) Bit	Off/On	Hex	Decimal	Function
0	—	—	—	Reserved.
1	—	—	—	Reserved.
2	Off	00	0	Double-width canceled.
	On	04	4	Double-width selected.
3	Off	00	0	Double-height canceled.
	On	08	8	Double-height selected.
4	—	—	—	Reserved.
5	—	—	—	Reserved.
6	—	—	—	Reserved.
7	Off	00	0	Underline mode is turned off.
	On	80	128	Underline mode is turned on.

Select an international character set

Name	Select an international character set																						
Format	ASCII : ESC R n Decimal : 27 82 n HEX : 1B 52 n																						
Description	<p>Selects international character set n from the following table:</p> <table border="1" style="margin-left: 40px;"> <thead> <tr> <th>n</th> <th>Character set</th> </tr> </thead> <tbody> <tr><td>0</td><td>U.S.A</td></tr> <tr><td>1</td><td>France</td></tr> <tr><td>2</td><td>Germany</td></tr> <tr><td>3</td><td>U.K</td></tr> <tr><td>4</td><td>Denmark I</td></tr> <tr><td>5</td><td>Sweden</td></tr> <tr><td>6</td><td>Italy</td></tr> <tr><td>7</td><td>Spain I</td></tr> <tr><td>8</td><td>Japan</td></tr> <tr><td>9</td><td>Norway</td></tr> </tbody> </table>	n	Character set	0	U.S.A	1	France	2	Germany	3	U.K	4	Denmark I	5	Sweden	6	Italy	7	Spain I	8	Japan	9	Norway
n	Character set																						
0	U.S.A																						
1	France																						
2	Germany																						
3	U.K																						
4	Denmark I																						
5	Sweden																						
6	Italy																						
7	Spain I																						
8	Japan																						
9	Norway																						

	10	Denmark II
	11	Spain II
	12	Latin America
	13	Korea
	14	Slovenia/Croatia
	15	China
Range	$0 \leq n \leq 15$	
Default	0	
Support modal	All the printers	
Note		
For example	<p>1B 40 1C 26 c3 c0 b9 fa 0d 0a 1B 40 1B 52 00 7b 23 24 40 5b 5c 5c 5d 5e 60 7b 7c 7d 7e 7d 0d 0a 1B 40 1C 26 B7 A8 B9 FA 0d 0a 1B 40 1B 52 01 7b 23 24 40 5b 5c 5c 5d 5e 60 7b 7c 7d 7e 7d 0d 0a 1B 40 1C 26 B5 C2 B9 FA 0d 0a 1B 40 1B 52 02 7b 23 24 40 5b 5c 5c 5d 5e 60 7b 7c 7d 7e 7d 0d 0a 1B 40 1C 26 D3 A2 B9 FA 0d 0a 1B 40 1B 52 03 7b 23 24 40 5b 5c 5c 5d 5e 60 7b 7c 7d 7e 7d 0d 0a 1B 40 1C 26 B5 A4 C2 F3 0d 0a 1B 40 1B 52 04 7b 23 24 40 5b 5c 5c 5d 5e 60 7b 7c 7d 7e 7d 0d 0a 1B 40 1C 26 C8 F0 B5 E4 0d 0a 1B 40 1B 52 05 7b 23 24 40 5b 5c 5c 5d 5e 60 7b 7c 7d 7e 7d 0d 0a 1B 40 1C 26 D2 E2 B4 F3 C0 FB 0d 0a 1B 40 1B 52 06 7b 23 24 40 5b 5c 5c 5d 5e 60 7b 7c 7d 7e 7d 0d 0a 1B 40 1C 26 CE F7 B0 E0 D1 C0 0d 0a 1B 40 1B 52 07 7b 23 24 40 5b 5c 5c 5d 5e 60 7b 7c 7d 7e 7d 0d 0a 1B 40 1C 26 C8 D5 B1 BE 0d 0a 1B 40 1B 52 08 7b 23 24 40 5b 5c 5c 5d 5e 60 7b 7c 7d 7e 7d 0d 0a 1B 40 1C 26 C5 B2 CD FE 0d 0a 1B 40 1B 52 09 7b 23 24 40 5b 5c 5c 5d 5e 60 7b 7c 7d 7e 7d 0d 0a 1B 40 B5 A4 C2 F3 32 0d 0a 1B 40 1B 52 0A 7b 23 24 40 5b 5c 5c 5d 5e 60 7b 7c 7d 7e 7d 0d 0a 1B 40 CE F7 B0 E0 D1 C0 32 0d 0a</p>	

	<p>1B 40 1B 52 0B 7b 23 24 40 5b 5c 5c 5d 5e 60 7b 7c 7d 7e 7d 0d 0a 1B 40 1C 26 C0 AD B6 A1 C3 C0 D6 DE 0d 0a 1B 40 1B 52 0C 7b 23 24 40 5b 5c 5c 5d 5e 60 7b 7c 7d 7e 7d 0d 0a 1B 40 1C 26 BA AB B9 FA 0d 0a 1B 40 1B 52 0D 7b 23 24 40 5b 5c 5c 5d 5e 60 7b 7c 7d 7e 7d 0d 0a 1B 40 1C 26 CB B9 C2 E5 CE C4 C4 E1 D1 C7 0d 0a 1B 40 1B 52 0E 7b 23 24 40 5b 5c 5c 5d 5e 60 7b 7c 7d 7e 7d 0d 0a 1B 40 1C 26 D6 D0 B9 FA 0d 0a 1B 40 1B 52 0F 7b 23 24 40 5b 5c 5c 5d 5e 60 7b 7c 7d 7e 7d 0d 0a</p>
--	---

Select character code table

Name	Select character code table
Format	<p>ASCII : ESC t n Decimal : 27 116 n HEX : 1B 74 n</p>
Description	n :select code page.

	N	Code Page	N	Code Page
	0	CP437 [U.S.A., Standard Europe]	26	Thai
	1	KataKana	27	CP720[Arabic]
	2	CP850 [Multilingual]	28	CP855
	3	CP860 [Portug ese]	29	CP857[Turkish]
	4	CP863 [Canadian-French]	30	WCP1250[Central Europe]
	5	CP865 [Nordic]	31	CP775
	6	WCP1251 [Cyrillic]	32	WCP1254[Turkish]
	7	CP866 Cyrillic #2	33	WCP1255[Hebrew]
	8	MIK[Cyrillic /Bulgarian]	34	WCP1256[Arabic]
	9	CP755 [East Europe, Latvian 2]	35	WCP1258[Vietnam]
	10	Iran	36	ISO-8859-2[Latin 2]
	11	reserve	37	ISO-8859-3[Latin 3]
	12	reserve	38	ISO-8859-4[Baltic]
	13	reserve	39	ISO-8859-5[Cyrillic]
	14	reserve	40	ISO-8859-6[Arabic]
	15	CP862 [Hebrew]	41	ISO-8859-7[Greek]
	16	WCP1252 Latin I	42	ISO-8859-8[Hebrew]
	17	WCP1253 [Greek]	43	ISO-8859-9[Turkish]
	18	CP852 [Latina 2]	44	ISO-8859-15 [Latin 3]
	19	CP858 Multilingual Latin I+Euro)	45	Thai2
	20	Iran II	46	CP856
	21	Latvian	47	Cp874
	22	CP864 [Arabic]	255	GBK2312
	23	ISO-8859-1 [West Europe]		
	24	CP737 [Greek]		
	25	WCP1257 [Baltic]		
Range	0 ≤ n ≤ 255			
Default	0			
Support modal	All the printers			
Note				
For example	1B 40 1C 2E 1B 74 00 80 81 82 83 84 85 86 87 88 89 8A 8B 8C 8D 8E 8F 90 91 92 93 94 95 96 97 98 9A 9B 9C 9D 9E 9F A0 A1 A2 A3 A4 A5 A6 A7 A8 A9 AA AB AC AD AE AF B0 B1 B2 B3 B4 B5 B6 B7 B8 B9 BA BB BC BD BE BF C0 C1 C2 C3 C4 C5 C6 C7 C8 C9 CA CB CC CD CE CF D0 D1 D2 D3 D4 D5 D6 D7 D8 D9 DA DB DC DD DE DF E0 E1 E2 E3 E4 E5 E6 E7 E8 E9 EA EB EC ED EE EF F0 F1 F2 F3 F4 F5 F6 F7 F8 F9 FA FB FC FD FE FF 0D 0A			

③ Bit image command

Print MSB BITMAP

Name	Print MSB Bitmap
Format	ASCII : DC2 V nL nH [d1 ... d48] Hex : 12 56 nL nH [d1 ... d48] Decimal : 18 86 nL nH [d1 ... d48]
Description	<p>This command use to print MSB format bitmap, The width of bitmap must the same as the printer mechanism Bitmap height: nL+nH*256 Bitmap format:</p> <p style="text-align: center;">$\ll n = nL + nH * 256 \gg$</p>
Range	
Default	
Support modal	All the printers
Note	
For example	12 56 01 00 FF

Print LSB bitmap

Name	Print LSB Bitmap
Format	ASCII : DC2 v nL nH [d1 ... d48] Hex : 12 76 nL nH [d1 ... d48] Decimal : 18 118 nL nH [d1 ... d48]
Description	<p>This command use to print LSB format bitmap, The width of bitmap must the same as the printer mechanism Bitmap height: nL+nH*256 Bitmap format:</p>

Range	
Default	
Support modal	All the printers
Note	
For example	

Select bit-image mode

Name	Select bit-image mode																				
Format	ASCII : ESC * m Hl Hh [d]k Decimal : 27 42 m Hl Hh [d]k HEX : 1B 2A m Hl Hh [d]k																				
Description	Selects a bit-image mode using m for the number of dots specified by nL and nH, as follows: <table style="margin-left: 40px; border-collapse: collapse;"> <thead> <tr> <th style="text-align: left;">m</th> <th style="text-align: left;">mode</th> <th style="text-align: left;">Horizontal Scale</th> <th style="text-align: left;">Vertical Scale</th> </tr> </thead> <tbody> <tr> <td>0</td> <td>8-dot single-density</td> <td>×2</td> <td>×3</td> </tr> <tr> <td>1</td> <td>8-dot double-density</td> <td>×1</td> <td>×3</td> </tr> <tr> <td>32</td> <td>24-dot single-density</td> <td>×2</td> <td>×1</td> </tr> <tr> <td>33</td> <td>24-dot double-density</td> <td>×1</td> <td>×1</td> </tr> </tbody> </table> Hl、Hh specifies the number of dots in the horizontal direction. (Hl+256×Hh) [d]k is bit-image mode datas	m	mode	Horizontal Scale	Vertical Scale	0	8-dot single-density	×2	×3	1	8-dot double-density	×1	×3	32	24-dot single-density	×2	×1	33	24-dot double-density	×1	×1
m	mode	Horizontal Scale	Vertical Scale																		
0	8-dot single-density	×2	×3																		
1	8-dot double-density	×1	×3																		
32	24-dot single-density	×2	×1																		
33	24-dot double-density	×1	×1																		
Range	XX58: m = 0、1、32、33 $1 \leq Hl + Hh \times 256 \leq 384$ $0 \leq d \leq 255$ $k = Hl + Hh \times 256$ (当 m = 0、1) $k = (Hl + Hh \times 256) \times 3$ (当 m = 32、33) XX80: m = 0、1、32、33 $1 \leq Hl + Hh \times 256 \leq 576$ $0 \leq d \leq 255$ $k = Hl + Hh \times 256$ (当 m = 0、1) $k = (Hl + Hh \times 256) \times 3$ (当 m = 32、33)																				
Default																					

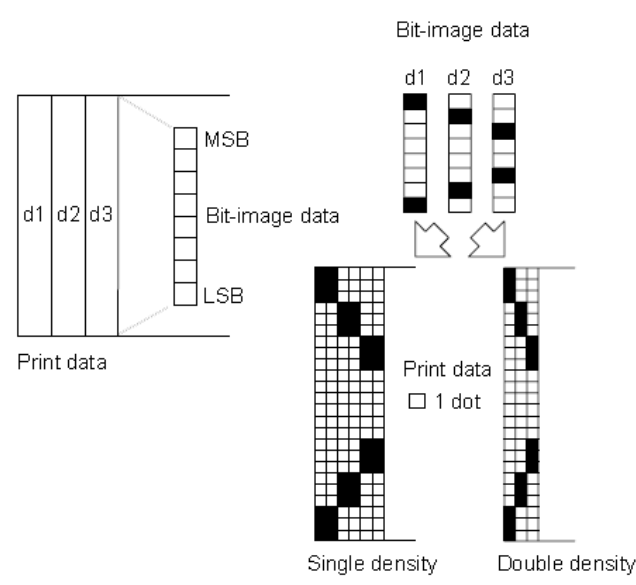
Support modal	All the printers
Note	<p>If the value of m is out of the specified range, nL and nH the data following are processed as normal data.</p> <p>The nL and nH indicate the number of dots in the bit image in the horizontal direction. The number of dots is calculated by $nL + nH \leq 256$.</p> <p>If the bit-image data input exceeds the number of dots to be printed on a line, the excess data is ignored.</p> <p>d indicates the bit-image data. Set a corresponding bit to 1 to print a dot or to 0 not to print a dot.</p> <p>After printing a bit image, the printer returns to normal data processing mode.</p> <p>This command is not affected by print modes (emphasized, double-strike, underline, character size, or white/black reverse printing), except upside-down printing mode.</p> <p>The relationship between the image data and the dots to be printed is described in Figure 3.11.3.</p>
	<p>When 8-dot bit image is selected:</p>  <p>The diagram illustrates the mapping of bit-image data to print data. On the left, 'Print data' is shown as a grid of three columns labeled d1, d2, and d3. To its right, 'Bit-image data' is shown as a vertical stack of bits, with the top bit labeled MSB and the bottom bit labeled LSB. On the right side, 'Bit-image data' is shown as three vertical columns labeled d1, d2, and d3. Below these, two 'Print data' grids are shown: 'Single density' and 'Double density'. A legend indicates that a white square represents '1 dot'. The caption '3.11.3' is centered below the grids.</p> <p>3.11.3</p> <p>When 24-dot bit image is selected:</p>

	<p style="text-align: center;">3.11.3</p>
For example	<pre>1B 40 1b 2a 00 0c 00 ff ff ff ff ff ff ff ff ff ff ff ff 1B 33 00 0A</pre>

Define downloaded bit image

Name	Define downloaded bit image
Format	ASCII : GS * x y d1...d(x*y*8) Decimal : 29 42 x y d1 ...d(x*y*8) HEX : 1D 2A x y d1...d(x*y*8)
Description	Defines a downloaded bit image using the number of dots specified by x and y. x specifies the number of dots in the horizontal direction. y specifies the number of dots in the vertical direction.
Range	$1 \leq x \leq 255$ $1 \leq y \leq 48$ $x*y \leq 1536$ $0 \leq d \leq 255$
Default	
Support modal	All the printers
Note	<p>If $x*y$ is out of the specified range, this command is disabled.</p> <p>The d indicates bit-image data. Data (d) specifies a bit printed as 1 and not printed as 0.</p> <p>The downloaded bit image definition is cleared when:</p> <ol style="list-style-type: none"> 1) ESC @ is executed. 2) ESC & is executed. 3) Printer is reset or the power is turned off. <p>The following figure shows the relationship between the downloaded bit image and the printed data.</p>

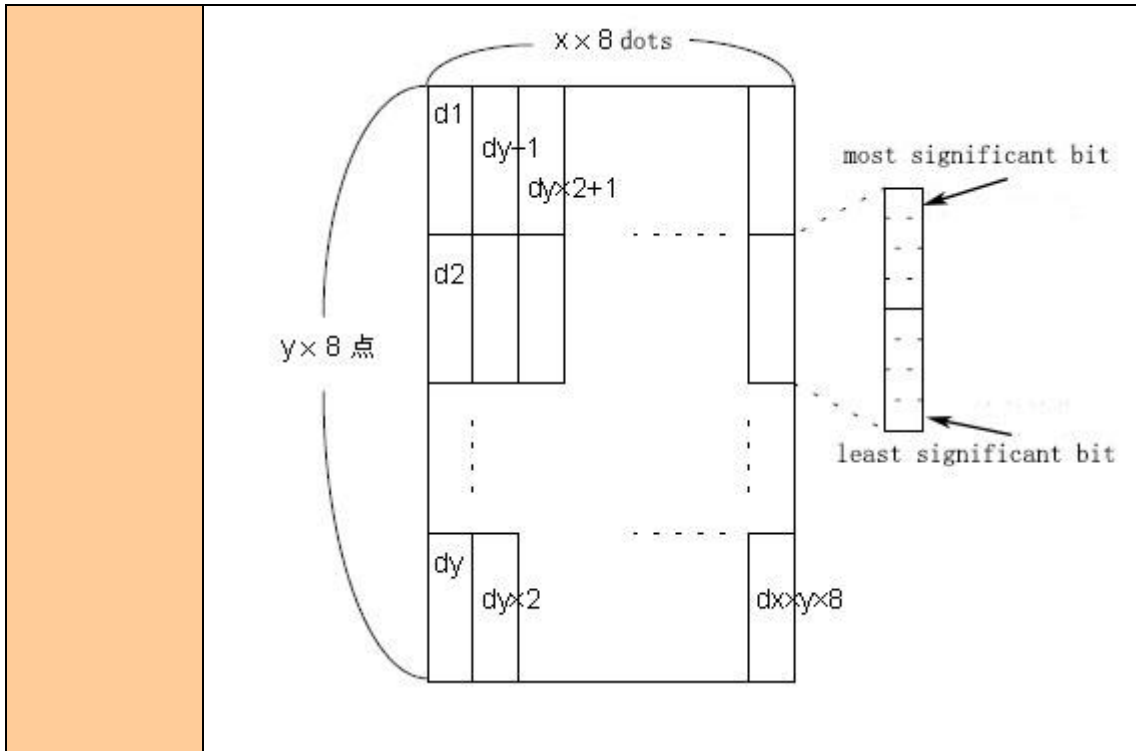

1B 40
 1D 2A 0a 08
 ff 00 00 00 00 00 00 00 00 00 ff 00 00 00 00 00 00 00 00 ff 00 00 00 00 00 00 00 00 ff 00 00 00 00 00 00 00 00
 ff 00 00 00 00 00 00 00 00 ff 00 00 00 00 00 00 00 00 ff 00 00 00 00 00 00 00 00 ff 00 00 00 00 00 00 00 00
 ff 00 00 00 00 00 00 00 00 ff 00 00 00 00 00 00 00 00 ff 00 00 00 00 00 00 00 00 ff 00 00 00 00 00 00 00 00
 00 00 00 00 00 ff 00 00 00 00 00 00 00 00 ff 00 00 00 00 00 00 00 ff 00 00 00 00 00 00 00 00 ff 00 00 00 00 00 00 00 00
 ff 00 00 00 00 00 00 00 00 ff 00 00 00 00 00 00 00 00 ff 00 00 00 00 00 00 00 00 ff 00 00 00 00 00 00 00 00
 00 ff 00 00 00 00 00 00 00 ff 00 00 00 00 00 00 00 00 ff 00 00 00 00 00 00 00 00 ff 00 00 00 00 00 00 00 00
 ff ff 00 00 00 00 00 00 00 00 ff 00 00 00 00 00 00 00 00 ff 00 00 00 00 00 00 00 00 ff 00 00 00 00 00 00 00 00
 00 00 ff 00 00 00 00 00 00 00 ff 00 00 00 00 00 00 00 00 ff 00 00 00 00 00 00 00 00 ff 00 00 00 00 00 00 00 00
 00 00 ff 00 00 00 00 00 00 00 ff 00 00 00 00 00 00 00 00 ff 00 00 00 00 00 00 00 00 ff 00 00 00 00 00 00 00 00
 ff 00 00 00 00 00 00 00 00 ff 00 00 00 00 00 00 00 00 ff 00 00 00 00 00 00 00 00 ff 00 00 00 00 00 00 00 00
 00 00 ff 00 00 00 00 00 00 00 ff 00 00 00 00 00 00 00 00 ff 00 00 00 00 00 00 00 00 ff 00 00 00 00 00 00 00 00
 00 00 ff ff 00 00 00 00 00 00 00 00 ff 00 00 00 00 00 00 00 00 ff 00 00 00 00 00 00 00 00 ff 00 00 00 00 00 00 00 00
 00 00 00 ff 00 00 00 00 00 00 00 00 ff 00 00 00 00 00 00 00 00 ff 00 00 00 00 00 00 00 00 ff 00 00 00 00 00 00 00 00
 00 00 00 ff 00 00 00 00 00 00 00 00 ff 00 00 00 00 00 00 00 00 ff 00 00 00 00 00 00 00 00 ff 00 00 00 00 00 00 00 00
 00 00 00 ff ff 00 00 00 00 00 00 00 00 ff 00 00 00 00 00 00 00 00 ff 00 00 00 00 00 00 00 00 ff 00 00 00 00 00 00 00 00
 00 00 00 00 ff 00 00 00 00 00 00 00 00 ff 00 00 00 00 00 00 00 00 ff 00 00 00 00 00 00 00 00 ff 00 00 00 00 00 00 00 00
 00 00 00 00 ff 00 00 00 00 00 00 00 00 ff 00 00 00 00 00 00 00 00 ff 00 00 00 00 00 00 00 00 ff 00 00 00 00 00 00 00 00
 00 00 ff 00 00 00 00 00 00 00 ff 00 00 00 00 00 00 00 00 ff 00 00 00 00 00 00 00 00 ff 00 00 00 00 00 00 00 00

For example

	00 00 00 00 ff 00 00 00 00 00 00 ff 00 00 00 00 00 00 ff 00 00 00 00 00 00 ff 00 00 00 00 00 ff 1D 2F 03
--	--

Print downloaded bit image

Name	Print downloaded bit image										
Format	ASCII : GS / m Decimal : 29 47 m HEX : 1D 2F m										
Description	Prints a downloaded bit image using the mode specified by m. m selects a mode from the table below: <table border="1" style="margin-left: 20px;"> <thead> <tr> <th>n</th> <th>Mode</th> </tr> </thead> <tbody> <tr> <td>0, 48</td> <td>Normal</td> </tr> <tr> <td>1, 49</td> <td>Double-width</td> </tr> <tr> <td>2, 50</td> <td>Double-height</td> </tr> <tr> <td>3, 51</td> <td>Quadruple</td> </tr> </tbody> </table>	n	Mode	0, 48	Normal	1, 49	Double-width	2, 50	Double-height	3, 51	Quadruple
n	Mode										
0, 48	Normal										
1, 49	Double-width										
2, 50	Double-height										
3, 51	Quadruple										
Range	$0 \leq m \leq 3$ $48 \leq m \leq 51$										
Default											
Support modal	All the printers										
Note	<p>This command is ignored if a downloaded bit image has not been defined.</p> <p>In standard mode, this command is effective only when there is no data in the print buffer.</p> <p>This command has no effect in the print modes (emphasized, double-strike, underline, character size, or white/black reverse printing), except for upsidedown printing mode.</p> <p>If the downloaded bit-image to be printed exceeds the printable area, the excess data is not printed.</p>										
For example											

Define NV bit image

Name	Define NV bit image
Format	ASCII : FS q n [xL xH yL yH d1...dk]1...[xL xH yL yH d1...dk]n Decimal : 28 113 n [xL xH yL yH d1...dk]1...[xL xH yL yH d1...dk]n HEX : 1C 71 n [xL xH yL yH d1...dk]1...[xL xH yL yH d1...dk]n
Description	Define the NV bit image specified by n. n specifies the number of the defined NV bit image. xL, xH specifies (xL xH 256) 8 dots in the horizontal direction for the NV bit image you are defining. yL, yH specifies (yL yH 256) 8 dots in the vertical direction for the NV bit image you are defining.
Range	$1 \leq n \leq 255$ $0 \leq xL \leq 255$

	$0 \leq xH \leq 3$ $(1 \leq (xL+xH*256) \leq 1023)$ $0 \leq yL \leq 255$ $0 \leq yH \leq 1$ $(1 \leq (yL+yH*256) \leq 288)$ $0 \leq d \leq 255$ $k = (xL+xH*256)*(yL+yH*256)*8$ Total defined data area = 64K Bytes
Default	
Support modal	All the printers
Note	<p>Frequent write command executions may damage the NV memory. Therefore, it is recommended to write the NV memory 10 times or less a day.</p> <p>The printer performs a hardware reset after the procedure to place the image into the NV memory. Therefore, user-defined characters, downloaded bit images should be defined only after completing this command. The printer clears the receive and print buffers and resets the mode to the mode that was in effect at power on. (this version is not support hardware reset)</p> <p>This command cancels all NV bit images that have already been defined by this command.</p> <p>From the beginning of the processing of this command till the finish of hardware reset, mechanical operations (including initializing the position of the print head when the cover is open, paper feeding using the FEED button, etc.) cannot be performed.</p> <p>During processing of this command, the printer is BUSY when writing data to the user NV memory and stops receiving data. Therefore it is prohibited to transmit the data, including real-time commands, during the execution of this command.</p> <p>NV bit image is a bit image defined in non-volatile memory by FS q and printed by FS p.</p> <p>In standard mode, this command is effective only when processed at thebeginning of the line.</p> <p>This command is effective when 7 bytes <FS yH> of the command areprocessed normally.</p> <p>When the amount of data exceeds the capacity left in the range defined by xL, xH, yL, yH, the printer processes xL, xH, yL, yH out of the defined range.</p> <p>In the first group of NV bit images, when any of the parameters xL, xH, yL, yH is out of the definition range, this command is disabled.</p> <p>In groups of NV bit images other than the first one, when the printer encounters xL, xH, yL, yH out of the defined range, it stops processing this command and starts writing into the NV images. At this time, NV bit images that haven't been defined are disabled (undefined), but any NV bit images before that are enabled.</p> <p>The d indicates the definition data. In data (d) a 1 bit specifies a dot to be printed and a 0 bit specifies a dot not to be printed.</p>

	<p>This command defines n as the number of a NV bit image. Numbers rise in order from NV bit image 01H. Therefore, the first data group [xL xH yL yH d1...dk] is NV bit image 01H, and the last data group [xL xH yL yH d1...dk] is NV bit image n. The total agrees with the number of NV bit images specified by the command FS p.</p> <p>The definition data for an NV bit image consists of [xL xH yL yH d1...dk]. Therefore, when only one NV bit image is defined n=1, the printer processes a data group [xL xH yL yH d1...dk] once. The printer uses ([data: (xL xH× 256)×(yL yH× 256)×8] [header :4]) bytes of NV memory.</p> <p>The definition area in this printer is a maximum of 192K bytes. This command can define several NV bit images, but cannot define bit image data whose total capacity [bit image data header] exceeds 192K bytes.</p> <p>The printer does not transmit ASB status or perform status detection during processing of this command even when ASB is specified.</p> <p>Once an NV bit image is defined, it is not erased by performing ESC @, reset, and power off.</p> <p>This command performs only definition of an NV bit image and does not perform printing. Printing of the NV bit image is performed by the FS pcommand.</p> <p>For example : xL = 64, xH = 0, yL = 96, yH = 0</p>
--	--

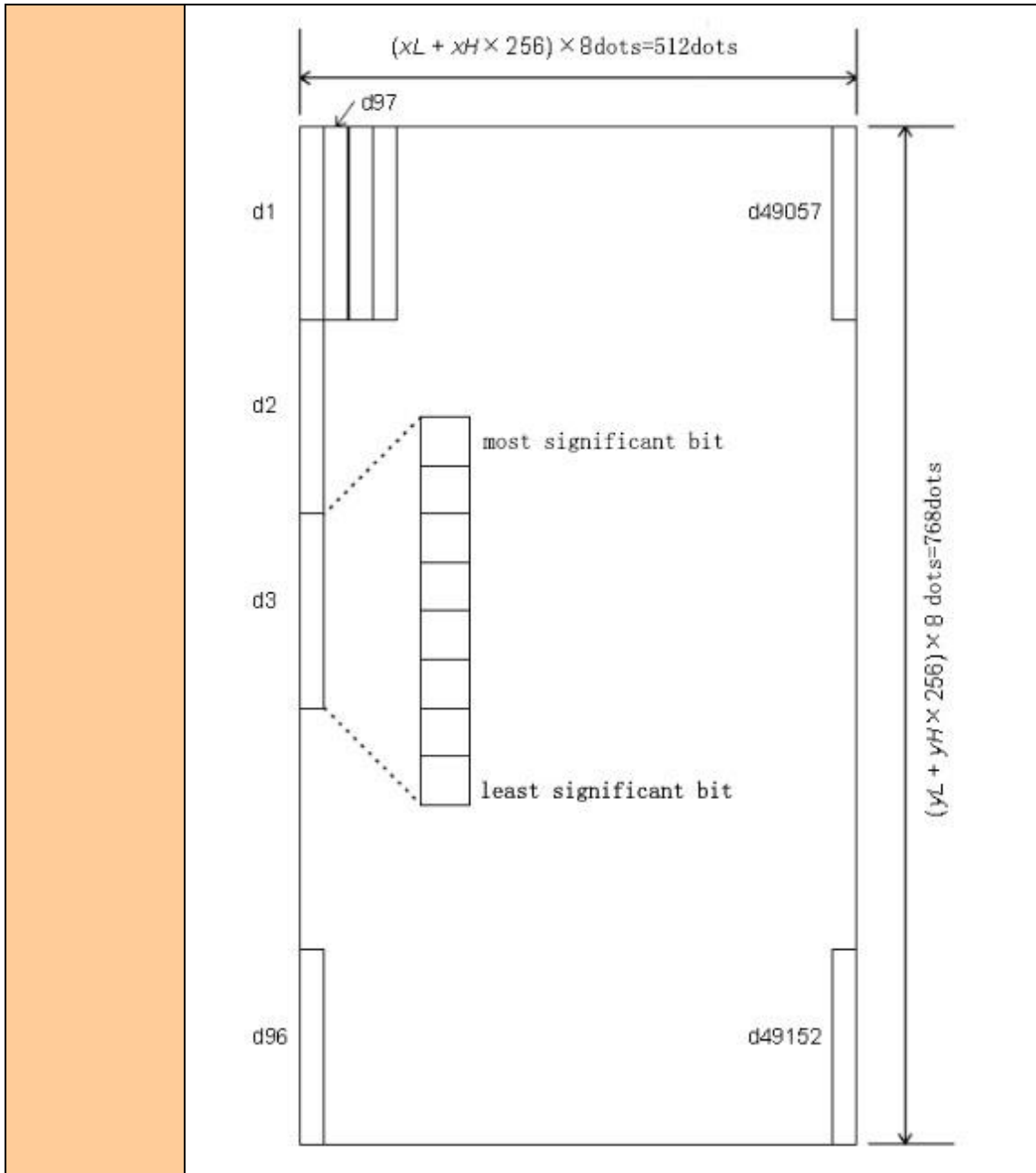

For example

```

1B 40
1C 71 01 10 00 08 00
ff ff ff ff ff ff ff ff ff ff ff ff ff ff ff ff ff ff ff ff ff ff ff ff ff ff ff ff ff ff
ff ff ff ff ff ff ff ff ff ff ff ff ff ff ff ff ff ff ff ff ff ff ff ff ff ff ff ff ff ff
ff ff ff ff ff ff ff 00 00 00 00 ff ff ff ff 00 00 00 00 ff ff ff ff 00 00 00 00 ff ff ff
ff 00 00 00 00 ff ff ff ff 00 00 00 00 ff ff ff ff 00 00 00 00 ff ff ff ff 00 00 00 00 ff
ff ff 00 00 00 00 ff ff ff ff 00 00 00 00 ff ff ff ff 00 00 00 00 ff ff ff ff 00 00 00
00 ff ff ff ff 00 00 00 00 ff ff ff ff ff ff ff ff ff ff ff ff ff ff ff ff ff ff ff ff ff ff
ff ff ff ff ff ff ff ff ff ff ff ff ff ff ff ff ff ff ff ff ff ff ff ff ff ff ff ff ff ff
ff ff ff ff ff ff ff ff ff ff ff ff ff ff ff ff ff ff ff ff ff ff ff ff ff ff ff ff ff ff
ff ff ff 00 00 00 00 ff ff ff ff 00 00 00 00 ff ff ff ff 00 00 00 00 ff ff ff ff 00 00 00
00 ff ff ff ff 00 00 00 00 ff ff ff ff 00 00 00 00 ff ff ff ff 00 00 00 00 ff ff ff ff 00
00 00 00 ff ff ff ff 00 00 00 00 ff ff ff ff 00 00 00 00 ff ff ff ff 00 00 00 00 ff ff ff
    
```

	<pre> ff 00 00 00 00 ff 00 00 00 00 ff ff ff ff 00 00 00 00 ff ff ff ff 00 00 00 00 ff ff ff ff 00 00 00 00 ff ff ff ff 00 00 00 00 ff ff ff ff 00 00 00 00 ff ff ff ff 00 00 00 00 ff ff ff ff 00 00 00 00 ff ff ff ff 00 00 00 00 ff ff ff ff 00 00 00 00 ff ff ff ff 00 00 00 00 ff ff ff ff 00 00 00 00 ff 00 00 00 00 ff ff ff ff 00 00 00 00 ff ff ff ff 00 00 00 00 ff ff ff ff 00 00 00 00 ff ff ff ff 00 00 00 00 ff ff ff ff 00 00 00 00 ff ff ff ff 00 00 00 00 ff ff ff ff 00 00 00 00 ff ff ff ff 00 00 00 00 ff ff ff ff 00 00 00 00 ff ff ff ff 00 00 00 00 ff 1C 70 01 00 </pre>
--	---

Print NV bit image

Name	Print NV bit image										
Format	ASCII : FS p n m Decimal : 28 112 n m HEX : 1C 70 n m										
Description	Prints NV bit image n using the mode specified by m. <table border="1" style="margin-left: 40px;"> <thead> <tr> <th>m</th> <th>Mode</th> </tr> </thead> <tbody> <tr> <td>0, 48</td> <td>Normal</td> </tr> <tr> <td>1, 49</td> <td>Double-width</td> </tr> <tr> <td>2, 50</td> <td>Double-height</td> </tr> <tr> <td>3, 51</td> <td>Quadruple</td> </tr> </tbody> </table>	m	Mode	0, 48	Normal	1, 49	Double-width	2, 50	Double-height	3, 51	Quadruple
m	Mode										
0, 48	Normal										
1, 49	Double-width										
2, 50	Double-height										
3, 51	Quadruple										
Range	$0 \leq m \leq 3$ $48 \leq m \leq 51$ $1 \leq n \leq 255$										
Default											
Support modal	All the printers										
Note	NV bit image is a bit image defined in non-volatile memory by FS q and printed by FS p . This command is not effective when the specified NV bit image has not been defined. In standard mode, this command is effective only when there is no data in the										

	<p>print buffer.</p> <p>This command is not affected by print modes (emphasized, underline, character size, white/black reverse printing, or 90° rotated characters, etc.), except upside-down printing mode.</p> <p>If the downloaded bit-image to be printed exceeds one line, the excess data is not printed.</p> <p>This command feeds dots (for the height n of the NV bit image) in normal and double-width modes, and (for the height $n - 2$ of the NV bit image) in doubleheight and quadruple modes, regardless of the line spacing specified by ESC 2 or ESC 3.</p> <p>After printing the bit image, this command sets the print position to the beginning of the line and processes the data that follows as normal data.</p>
For example	

Print raster bit image

[Name] Print raster bit image

[Format] ASCII GS v 0 m x L x H y L y H d1...dk

Hex 1D 76 30 m x L x H y L y H d1...dk

Decimal 29 118 48 m x L x H y L y H d1...dk

[Range] $0 \leq m \leq 3$, $48 \leq m \leq 51$

$1 \leq (x L + x H \times 256) \leq 65535$ ($0 \leq x L \leq 255$, $0 \leq x H \leq 255$)

$1 \leq (y L + y H \times 256) \leq 2303$ ($0 \leq y L \leq 255$, $0 \leq y H \leq 8$)

$0 \leq d \leq 255$

$k = (x L + x H \times 256) \times (y L + y H \times 256)$

[Description] • Prints a raster bit image using the mode specified by m.

m	Mode	Vertical direction (DPI)	Horizontal direction (DPI)
0,48	Normal	200	200
1,49	Double-width	200	100
2,50	Double-height	100	200
3,51	Quadruple	100	100

• $x L$, $x H$ specify the number of bytes in the horizontal direction as $(x L + x H \times 256)$.

• $y L$, $y H$ specify the number of dots in the vertical direction as $(y L + y H \times 256)$.

• d specifies the defined data (raster format).

④ Tab command

Horizontal tab

Name	Horizontal tab
Format	ASCII : HT Decimal : 9 HEX : 09
Description	Moves the print position to the next horizontal tab position.
Range	
Default	
Support modal	All the printers
Note	<p>This command is ignored unless the next horizontal tab position has been set.</p> <p>If the next horizontal tab position exceeds the printing area, the printer sets the printing position to [printing area width + 1].</p> <p>Horizontal tab positions are set with ESC D.</p> <p>If this command is received when the printing position is at [printing area width + 1], the printer executes print buffer-full printing of the current line and horizontal tab processing from the beginning of the next line.</p>
For example	

Set horizontal tab positions

Name	Set horizontal tab positions
Format	ASCII : ESC D [d]k NUL Decimal : 27 68 [d]k 0 HEX : 1B 44 [d]k 00
Description	<p>Sets horizontal tab positions.</p> <p>d[k] specifies the column number for setting a horizontal tab position from the beginning of the line.</p> <p>k indicates the total number of horizontal tab positions to be set.</p> <p>NULL is end mark.</p>
	<p>XX58: $1 \leq d \leq 46$ ($d_1 < d_2 < \dots < d_k$, $1 \leq k \leq 16$)</p> <p>XX80: $1 \leq d \leq 70$ ($d_1 < d_2 < \dots < d_k$, $1 \leq k \leq 16$)</p>
Default	[d]k = 0
Support modal	All the printers
Note	Set the Tab position:

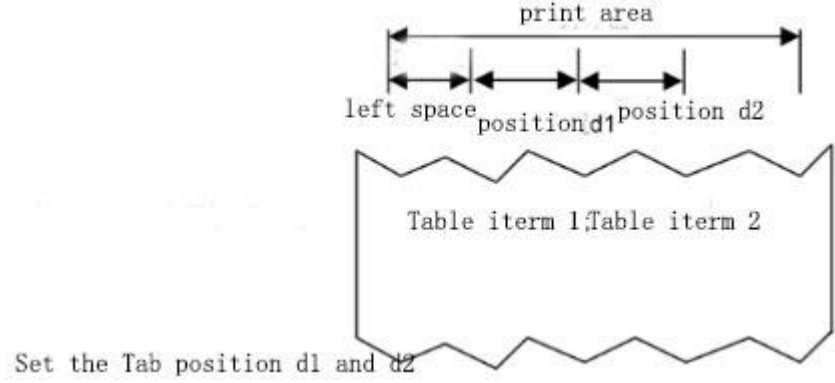
	 <p>Set the Tab position d1 and d2</p> <p>The horizontal tab position is stored as a value of [character width n] measured from the beginning of the line. The character width includes the right-side character spacing, and double-width characters are set with twice the width of normal characters.</p> <p>This command cancels the previous horizontal tab settings.</p> <p>When setting n = 8, the print position is moved to column 9 by sending HT.</p> <p>Up to 16 tab positions (k = 16) can be set. Data exceeding 16 tab positions is processed as normal data.</p> <p>Transmit [n]k in ascending order and place a NUL code 0 at the end.</p> <p>When [n]k is less than or equal to the preceding value [n]k-1, tab setting is finished and the following data is processed as normal data.</p> <p>ESC D NUL cancels all horizontal tab positions.</p> <p>The previously specified horizontal tab positions do not change, even if the character width changes.</p> <p>The character width is memorized for each standard mode.</p>
For example	<pre>1B 40 1C 26 1B 44 10 18 00 B1 E0 BA C5 09 C3 FB B3 C6 09 BC DB B8 F1 28 D4 AA 29 0D 0A 1B 44 10 18 00 31 09 B0 D7 B2 CB 09 31 2E 35 0D 0A 1B 44 10 18 00 32 09 C7 D1 D7 D3 09 32 0D 0A 1B 44 10 18 00 33 09 B6 B9 D1 BF 09 31 0D 0A</pre>



⑤ Bar code command

Select printing position for HRI characters

Name	Select printing position for HRI characters
Format	ASCII: GS H n Decimal: 29 72 n HEX: 1D 48 n
Description	Selects the printing position of HRI characters when printing a bar code. n



	selects the printing position as follows: <table border="1" style="margin-left: 20px;"> <thead> <tr> <th>n</th> <th>Printing position</th> </tr> </thead> <tbody> <tr> <td>0, 48</td> <td>Not printed</td> </tr> <tr> <td>1, 49</td> <td>Above the bar code</td> </tr> <tr> <td>2, 50</td> <td>Below the bar code</td> </tr> <tr> <td>3, 51</td> <td>Both above and below the bar code</td> </tr> </tbody> </table>	n	Printing position	0, 48	Not printed	1, 49	Above the bar code	2, 50	Below the bar code	3, 51	Both above and below the bar code
n	Printing position										
0, 48	Not printed										
1, 49	Above the bar code										
2, 50	Below the bar code										
3, 51	Both above and below the bar code										
Range	$0 \leq n \leq 3$ or $48 \leq n \leq 51$										
Default	$n = 0$										
Support modal	All the printers										
Note	ESC @,dump and restart,Reset the printer,This command setting failure.										
For example											

Select bar code height

Name	Select bar code height
Format	ASCII : GS h n Decimal : 29 104 n HEX : 1D 68 n
Description	Selects the height of the bar code. n specifies the number of dots in the vertical direction. <div style="text-align: center; margin-top: 10px;">  height:50  height:100 </div>
Range	$1 \leq n \leq 255$
Default	$n = 64$
Support modal	All the printers
Note	ESC @,dump and restart,Reset the printer,This command setting failure.
For example	

Set bar code width

Name	Set bar code width
Format	ASCII : GS w n Decimal : 29 119 n HEX : 1D 77 n
Description	Set bar code width unit to n, Parameters n meaning as follow:

	 width:3  width:4
Range	$1 \leq n \leq 6$
Default	$n = 2$
Support modal	All the printers
Note	ESC @,dump and restart,Reset the printer,This command setting failure.
For example	

Print bar code

Name	Print bar code
Format	<p>(A) ASCII : GS k m [d]k NUL Decimal : 29 107 m [d]k NUL HEX : 1D 6B m [d]k NUL</p> <p>(B) ASCII : GS k m n [d]k Decimal : 29 107 m n [d]k HEX : 1D 6B m n [d]k</p>
Description	<p>Selects a bar code system and prints the bar code. m selects a bar code system as follows:</p>

m	Bar Code System	Number of Characters	Remarks
①	0	UPC-A	11 k 12 48 d 57
	1	UPC-E	11 k 12 48 d 57
	2	JAN13 (EAN13)	12 k 13 48 d 57
	3	JAN 8 (EAN8)	7 k 8 48 d 57
	4	CODE39	1 k' 48 d 57, 65 d 90, 32, 36, 37, 43, 45, 46, 47
	5	ITF	1 k (even number) 48 d 57
	6	CODABAR	1 k' 48 d 57, 65 d 68, 36, 43, 45, 46, 47, 58
②	65	UPC-A	11 n 12 48 d 57
	66	UPC-E	11 n 12 48 d 57
	67	JAN13 (EAN13)	12 n 13 48 d 57
	68	JAN 8 (EAN8)	7 n 8 48 d 57
	69	CODE39	1 n 255 48 d 57, 65 d 90, 32, 36, 37, 43, 45, 46, 47
	70	ITF	1 n 255 (even number) 48 d 57
	71	CODABAR	1 n 255 48 d 57, 65 d 68, 36, 43, 45, 46, 47, 58
	72	CODE93	1 n 255 0 d 127
	73	CODE128	2 n 255 0 d 127

[Notes for ①]

This command ends with a NUL code.

When the bar code system used is UPC-A or UPC-E, the printer prints the bar code data after receiving 12 bytes of bar code data and processes the following data as normal data.

When the bar code system used is JAN13 (EAN13), the printer prints the bar code after receiving 13 bytes of bar code data and processes the following data as normal data.

When the bar code system used is JAN8 (EAN8), the printer prints the bar

code after receiving 8 bytes of bar code data and processes the following data as normal data.

The number of data for the ITF bar code must be even numbers. When an odd number of bytes of data is input, the printer ignores the last received data.

[Notes for ②]

n indicates the number of bar code data bytes, and the printer processes n bytes from the next character data as bar code data.

If n is outside the specified range, the printer stops command processing and processes the following data as normal data.

[Notes in standard mode]

If d is outside the specified range, the printer only feeds paper and processes the following data as normal data.

If the horizontal size exceeds printing area, the printer only feeds the paper.

This command feeds as much paper as is required to print the bar code, regardless of the line spacing specified by ESC 2 or ESC 3.

This command is enabled only when no data exists in the print buffer. When data exists in the print buffer, the printer processes the data following m as normal data.

After printing the bar code, this command sets the print position to the beginning of the line.

This command is not affected by print modes (emphasized, double-strike, underline, character size, white/black reverse printing, or 90 rotated character, etc.), except for upside-down printing mode.

[Example] Printing GS k 72 7 67 111 100 101 13 57 51

Control character			HRI character	Control character			HRI character
ASCII	Hex	Decimal		ASC II	Hex	Decima l	
NUL	00	0	■U	DEL	10	16	■P
SOH	01	1	■A	DC1	11	17	■Q
STX	02	2	■B	DC2	12	18	■R
ETX	03	3	■C	DC3	13	19	■S
EOT	04	4	■D	DC4	14	20	■T
ENQ	05	5	■E	NAK	15	21	■U
ACK	06	6	■F	SYN	16	22	■V
BEL	07	7	■G	ETB	17	23	■W
BS	08	8	■H	CAN	18	24	■X
HT	09	9	■I	EM	19	25	■Y
LF	0A	10	■J	SUB	1A	26	■Z
VT	0B	11	■K	ESC	1B	27	■A
FF	0C	12	■L	FS	1C	28	■B
CR	0D	13	■M	GS	1D	29	■C
SO	0E	14	■N	RS	1E	30	■D
SI	0F	15	■O	US	1F	31	■E
				DEL	7F	127	■T



Range	(A) $0 \leq m \leq 6$ (B) $65 \leq m \leq 74$
Default	
Support modal	All the printers
Note	
For example	<p>1b 40 1d 48 02 1d 68 64 1d 77 03 30 0D 0A 1d 6b 00 30 31 32 33 34 35 36 37 38 39 31 00 31 0D 0A 1d 6b 01 30 31 32 33 34 35 36 37 38 39 31 00 32 0D0A 1d 6b 02 30 31 32 33 34 35 36 37 38 39 31 32 00 33 0D 0A 1d 6b 03 30 31 32 33 34 35 36 37 00 34 0D 0A 1D 6B 04 30 31 32 41 42 20 24 25 2B 2D 2E 2F 00 35 0D 0A 1d 6b 05 30 31 32 33 34 35 36 37 38 39 31 32 00 36 0D 0A 1d 6b 06 2D 31 32 42 24 2B 2D 2E 00 1d 6b 06 43 31 32 33 34 35 36 34 38 39 00</p> <p>36 35 0D 0A 1d 6b 41 0c 31 32 33 34 35 36 37 38 39 30 31 32 36 36 0D 0A 1d 6b 42 0c 30 32 33 34 35 36 30 30 30 38 39 36 37 0D 0A 1d 6b 43 0c 30 32 33 34 35 36 30 30 30 38 39 36 38 0D 0A 1d 6b 44 08 30 32 33 34 35 36 30 30 36 39 20 20 4e 4f 20 24 25 2b 2d 2e 2f 31 32 33 34 35 36 30 30 0D 0A 1d 6b 45 11 4e 4f 20 24 25 2b 2d 2e 2f 31 32 33 34 35 36 30 30 37 30 20 20 20 30 32 33 34 35 36 30 30 C5 BC CA FD 0D 0A 1d 6b 46 09 30 31 32 33 34 35 36 30 30 37 31 0d 0a 1d 6b 47 05 32 33 34 35 36 37 32 0d 0a 1d 6b 48 0b 32 33 34 35 36 41 42 2e 2f 2b 2c 37 33 0d0a 1d 6b 49 0A 7B 42 4E 6F 2E 7B 43 0C 22 38</p>

⑥ QR CODE COMMAND

Set the model type

Name	Set the model type
Format	ASCII : GS (k pL pH cn fn n Decimal : 29 40 107 pL pH cn fn n HEX : 1D 28 6b pL pH cn fn n
Description	Set the model type
Range	pL=3, pH=0 cn=49 fn=67 $0 \leq n \leq 16$
Default	n=3
Support modal	All the printers
Note	Set the QR code size of the smallest unit of graphics module[n dots× n dots].
For example	

Set the QR code error correction level error (ECC)

Name	Set the QR code error correction level error (ECC)															
Format	ASCII : GS (k pL pH cn fn n Decimal: 29 40 107 pL pH cn fn n HEX : 1D 28 6b pL pH cn fn n															
Description	Set the QR code error correction level error															
Range	pL=3, pH=0 cn=49 fn=69 $48 \leq n \leq 51$															
Default	n=48															
Support modal	All the printers															
Note	Set the QR code error correction level error <table border="1" style="margin-left: 40px;"> <thead> <tr> <th>n</th> <th>function</th> <th>The general proportion of recovery (%)</th> </tr> </thead> <tbody> <tr> <td>48</td> <td>Error correction level L</td> <td>7</td> </tr> <tr> <td>49</td> <td>Error correction level m</td> <td>15</td> </tr> <tr> <td>50</td> <td>Error correction level q</td> <td>25</td> </tr> <tr> <td>51</td> <td>Error correction level h</td> <td>30</td> </tr> </tbody> </table>	n	function	The general proportion of recovery (%)	48	Error correction level L	7	49	Error correction level m	15	50	Error correction level q	25	51	Error correction level h	30
n	function	The general proportion of recovery (%)														
48	Error correction level L	7														
49	Error correction level m	15														
50	Error correction level q	25														
51	Error correction level h	30														
For example																

Set the QR code graphic data

Name	Set the QR code graphic data
Format	ASCII : GS (k pL pH cn fn m d1...dk

	Decimal : 29 40 107 pL pH cn fn m d1...dk HEX : 1D 28 6b pL pH cn fn m d1...dk
Description	Set the QR code graphic data.
Range	$4 \leq (pL + pH \times 256) \leq 7092$ ($0 \leq pL \leq 255, 0 \leq pH \leq 28$) cn=49 fn=80 m=48 $0 \leq d \leq 255$ $k = (pL + pH \times 256) - 3$
Default	
Support modal	All the printers
Note	Set the QR code graphic data(d1...dk)to QR code buffer. (d1...dk) ((pL + pH×256)-3) Byte as a graphic data is processed.
For example	

Print store QR codes graphics

Name	Print store QR codes graphics
Format	ASCII : GS (k pL pH cn fn m Decimal : 29 40 107 pL pH cn fn m HEX : 1D 28 6b pL pH cn fn m
Description	Print store QR codes graphics
Range	pL=3, pH=0 cn=49 fn=81 m=48
Default	
Support modal	All the printers
Note	Print store QR codes graphics. The user must consider QR code graphic space (QR code graphics about spacing and the spacing of up and down) .
For example	1b 40 1d 28 6b 03 00 31 43 03 1d 28 6b 03 00 31 45 30 1d 28 6b 06 00 31 50 30 41 42 43 1b 61 01 1d 28 6b 03 00 31 52 30 1d 28 6b 03 00 31 51 30

⑦ STATUS COMMAND

Transmit status

Name	Transmit status
Format	ASCII : GS r n Decimal : 29 114 n

	HEX : 1D 72 n																																		
Description	Transmits the status specified by n as follows:																																		
	<table border="1"> <thead> <tr> <th>n</th> <th>Function</th> </tr> </thead> <tbody> <tr> <td>1.49</td> <td>Transmits paper sensor status</td> </tr> <tr> <td></td> <td></td> </tr> <tr> <td></td> <td></td> </tr> </tbody> </table>	n	Function	1.49	Transmits paper sensor status																														
	n	Function																																	
	1.49	Transmits paper sensor status																																	
Range	n = 1, 49																																		
Default																																			
Support modal	All the printers																																		
Note	<p>When using a serial interface</p> <p>When DTR/DSR control is selected, the printer transmits only 1 byte after confirming the host is ready to receive data (DSR signal is SPACE). If the host computer is not ready to receive data (DSR signal is MARK), the printer waits until the host is ready.</p> <p>When XON/XOFF control is selected, the printer transmits only 1 byte without confirming the condition of the DSR signal.</p> <p>This command is executed when the data in the receive buffer is developed. Therefore, there may be a time lag between receiving this command and transmitting the status, depending on the receive buffer status.</p> <p>When Auto Status Back (ASB) is enabled using GS a, the status transmitted by GS r and the ASB status must be differentiated using.</p> <p>The status types to be transmitted are shown below:</p>																																		
	<table border="1"> <thead> <tr> <th>Bit</th> <th>Off/On</th> <th>Hex</th> <th>Decimal</th> <th>Status for ASB</th> </tr> </thead> <tbody> <tr> <td>0,1</td> <td>-</td> <td>-</td> <td>-</td> <td>Undefined.</td> </tr> <tr> <td rowspan="2">2,3</td> <td>Off</td> <td>00</td> <td>0</td> <td>Paper roll end sensor: paper adequate.</td> </tr> <tr> <td>On</td> <td>(0C)</td> <td>(12)</td> <td>Paper roll end sensor: paper near end.</td> </tr> <tr> <td>4</td> <td>Off</td> <td>00</td> <td>0</td> <td>Not used. Fixed to Off.</td> </tr> <tr> <td>5,6</td> <td>-</td> <td>-</td> <td>-</td> <td>Undefined.</td> </tr> <tr> <td>7</td> <td>Off</td> <td>00</td> <td>0</td> <td>Not used. Fixed to Off.</td> </tr> </tbody> </table>	Bit	Off/On	Hex	Decimal	Status for ASB	0,1	-	-	-	Undefined.	2,3	Off	00	0	Paper roll end sensor: paper adequate.	On	(0C)	(12)	Paper roll end sensor: paper near end.	4	Off	00	0	Not used. Fixed to Off.	5,6	-	-	-	Undefined.	7	Off	00	0	Not used. Fixed to Off.
	Bit	Off/On	Hex	Decimal	Status for ASB																														
	0,1	-	-	-	Undefined.																														
	2,3	Off	00	0	Paper roll end sensor: paper adequate.																														
		On	(0C)	(12)	Paper roll end sensor: paper near end.																														
	4	Off	00	0	Not used. Fixed to Off.																														
	5,6	-	-	-	Undefined.																														
	7	Off	00	0	Not used. Fixed to Off.																														
	<p>Paper sensor status (n = 1, 49):</p> <p>Bits 2 and 3: When the paper end sensor detects a paper end, the printer goes offline and does not execute this command. Therefore, bits 2 and 3 do not transmit the status of paper end.</p>																																		
For example																																			

Real-time transmission status

Name	Real-time transmission status
Format	ASCII : DLE EOT n
	Decimal : 16 4 n
	HEX : 10 04 n
Description	<p>n = 1: printer status</p> <p>n = 2: send offline status</p>

	n = 3: Transmission error status n = 4: Transmission paper sensor status				
Range	1 ≤ n ≤ 4				
Default					
Support modal	All the printers				
Note	n=1: printer status				
	bit	0/1	HEX	Decimal	Function
	0	0	00	0	0
	1	1	02	2	1
	2	0	00	0	Open one or two cash drawer (No cash drawer is fixed to 0)
		1	04	4	Close cash drawer
	3	0	00	0	On-line
		1	08	8	Off-line
	4	1	10	16	1
	5, 6		--	--	Undefined
	7	0	00	00	The paper has been torn away
		1	80	96	Paper not to tear away
	n=2: send offline status				
	位	0/1	HEX	Decimal	function
	0	0	00	0	0
	1	1	02	2	1
	2	0	00	0	Close paper warehouse
		1	04	4	Open paper warehouse
	3	0	00	0	Not push Feed button
		1	08	8	Push feed button
	4	1	10	16	1
	5	0	00	0	Paper normal
		1	20	32	Paper out
	6	0	00	00	Normal status
		1	40	64	Error status
	7	0	00	0	0
	n=3: Transmission error status				
	bit	0/1	HEX	Decimal	function
	0	0	00	0	0
	1	1	02	2	1
	2		--	--	Undefined
	3	0	00	0	cutter normal
		1	08	8	Cutter error

	4	1	10	16	1	
	5	0	00	0	Unrecoverable Error	
		1	20	32	Unrecoverable Error	
	6	0	00	00	Print head temperature and voltage are normal	
		1	40	64	Print head temperature and voltage are over range.	
	7	0	00	0	0	
	n=4: Transmission paper sensor status					
	bit	0/1	HEX	Decimal	Function	
	0	0	00	0	0	
	1	1	02	2	1	
2,	0	00	0	normal status		
	3	1	0C	12	paper will out	
4	1	10	16	1		
5,	0	00	0	normal status		
	6	1	60	96	Paper out	
7	0	00	0	0		
For example	10 04 01 10 04 02 10 04 03 10 04 04					

Send real-time request to printer

[Name] Send real-time request to printer

[Format] ASCII DLE ENQ n

Hex 10 05 n

Decimal 16 5 n

[Range] n = 1, 2

[Description] • Responds to a request in real-time from the host PC.

n	Function
1	Recovers from a recoverable error and restarts printing from the line where the error occurred.
2	Recovers from a recoverable error after clearing the receive and print buffers. • This command is ignored unless a recoverable error has occurred.

- [Notes]
- Use this command after removing the cause of the error.
 - Take the following into consideration:
 - If the received data includes a data string matching this command, the printer performs the command. Users must consider this.

Example: Graphic data might accidentally include a data string matching this command.

- Do not embed this command within another command.

Example: Graphic data might include this command.

Enable/Disable Automatic Status Back (ASB)

Name	Enable/Disable Automatic Status Back (ASB)				
Format	ASCII : GS a n Decimal : 29 97 n HEX : 1d 61 n				
Description	When ASB is enabled, the printer will send the changed status to PC automatically.				
	bit	off/on	HEX	Decimal	ASB status
	0	-	-	-	Undefined
	1	-	-	-	Undefined
	2	off	00	0	error status prohibition
		on	04	4	Error status allows
	3	off	00	0	Paper sensor status prohibition
		on	08	8	Paper sensor status allows
4-7	-	-	-	Undefined	
Range	0≤n≤255				
Default					
Support modal	All the printers				
Note					
For example	1D 61 08				

Set the process ID response

[Name] Set the process ID response

[Format] ASCII GS (H p L p H fn m d1 d2 d3 d4
 Hex 1D 28 48 p L p H fn m d1 d2 d3 d4
 Decimal 29 40 72 p L p H fn m d1 d2 d3 d4

[Range] $(p L + p H \times 256) = 6$ (p L =6, p H = 0)

fn = 48

m = 48

$32 \leq d \leq 126$

[Description] • Saves the process ID specified by (d1, d2, d3, d4) for the data processed immediately before this function.

⑧ Other command

Initialize printer

Name	Initialize printer
Format	ASCII: ESC @ Decimal: 27 64 HEX: 1B 40
Description	Clears the data in the print buffer and resets the printer mode to the mode that was in effect when the power was turned on.
Range	
Default	
Support modal	All the printers
Note	
For example	

Printing test paper

Name	Printing test paper
Format	ASCII: DC2 T Decimal: 18 94 HEX: 12 54
Description	Printing test page
Range	
Default	
Support modal	All the printers
Note	
For example	1B 40 12 54

Select cut mode and cut paper

[Name] Select cut mode and cut paper

[Format] <A> ASCII GS V m

Hex 1D 56 m

Decimal 29 86 m

 ASCII GS V m n

Hex 1D 56 m n

Decimal 29 86 m n

[Range] <A> m = 0, 1, 48, 49

 m = 65, 66, $0 \leq n \leq 255$

[Description] • Executes paper cutting specified by m.

m		Paper cutting patterns
<A>	0, 48	Full-cut
	1, 49	Semi-cut
	65, 66	Feeds paper to (cutting position + $[n \times (\text{vertical motion unit})]$) and cuts the paper.

[Note] • This printer executes a partial cut (one point left uncut).

Partial cut (one point left uncut)

[Name] Partial cut (one point left uncut)

[Format] ASCII ESC i

Hex 1B 69

Decimal 27 105

[Description] • Executes a partial cut of the roll paper.

[Note] • This printer executes a partial cut (one point left uncut).

Partial cut (three points left uncut)

[Name] Partial cut (three points left uncut)

[Format] ASCII ESC m

Hex 1B 6D

Decimal 27 109

[Description] • Executes a partial cut of the roll paper.

[Note] • This printer executes a partial cut (one point left uncut).

Set the print concentration

Name	Set the print concentration
Format	ASCII: ESC 7 n1 n2 n3 Decimal: 27 55 n1 n2 n3 HEX: 1B 37 n1 n2 n3
Description	Set “max heating dots”, “heating time”, “heating interval” ; • n1 = 0-255 Max printing dots, Unit(8dots), Default:9(80 dots); • n2 = 3-255 Heating time, Unit(10us),Default:80(800us); • n3 = 0-255 Heating interval,Unit(10us), Default:2(20us); The more max heating dots, the more peak current will cost when printing, the faster printing speed. The max heating dots is 8*(n1+1); The more heating time, the more density , but the slower printing speed. If heating time is too short, blank page may occur. The more heating interval, the more clear, but the slower printing speed.
Range	
Default	
Support modal	All the printers
Note	‘heating time’、‘heating interval’ PCB will automatically adjust according to the input voltage
For example	Heating dots: 80dots, heating time: 800us, heating interval: 200us。 1B 40 1B 37 09 50 02 12 54 Heating dots: 80dot, heating time: 1600us, heating interval: 200us。 1B 40

	1B 37 09 A0 02 12 54 It is observed that the more heating time,the more printing dark.
--	--